



www.rp-group.com

LIGHT GETS SMART.
INTELLIGENT LIGHT MANAGEMENT BY APP.

CASAMBI
INSIDE

RP **ROPAG**
PART OF RP-GROUP

CONTENTS

Benefits at a glance	2
What can CASAMBI do	3
Light gets smart	4
Functions of the app	6
Gestures	8
iBeacon technology	8
CASAMBI for Hue	8
Security	9
Switching principle	11
The mesh network	11
CBU-ASD module	12
CBU-DCS DALI Controller	14
CBU-TED module	15
PWM4 module	16
CASA ROLLO Roller Shutter Control & CASA RELAIS Control for ohmic consumers	18
LED Power Converter CASAMBI V2	20
LED Power Converter CASAMBI V2 PWM300	21
LED Converter with Bluetooth controller	22
CBU-BOX	23
XPRESS wireless light switch	24
Push button interface	25
CASA BULB E27 illuminant	26
Panels	28
LAVA free-standing luminaire	36
Exterior façade and ceiling luminaires	37
CANTONE downlight	38
Moisture-proof diffuser luminaires	40
High-bay luminaire	42
Floodlight	44
LED strips	46
Motion detectors	48
Legend	55

BENEFITS AT A GLANCE

Fantastic features

- Intelligent timer to control your luminaires
- Groups of luminaires and lighting scenes

Straightforward and flexible

- No extra cables
- Flexible to extend

Simple and user friendly

- Straightforward configuration
- User-friendly software

Quick to connect

- No additional antennae are required
- Quick to connect thanks to Bluetooth Low Energy
- Luminaires and modules form a network and communicate with each other
- No central unit required

Small and space saving

- Compact modules for wall or ceiling mounting



WHAT CAN CASAMBI DO?

CASAMBI is the simplest and most natural way of controlling your LED luminaires. Setting up the app was designed to be as easy and intuitive as possible. To get you quick and impressive results so you can rediscover your lighting.

Using CASAMBI you can control up to 127 luminaires at once using your smartphone, tablet or smartwatch, and define parameters such as brightness and colour for each luminaire or luminaire group.

The timer enables you to automate entire lighting scenes. Once programmed, your smartphone no longer needs to be in range of a CASAMBI – the timer continues to run independently.

Use your conventional light switches to revert to the lighting parameters stored in the app, suddenly making even the humble light switch smart. Using motion or presence sensors you can also trigger operations and control your luminaires.

It doesn't matter if you have fluorescent lamps, high voltage halogen lights (230 V) or the most diverse LED lighting solutions. This brilliant light system can handle it all. Luminaires can be easily integrated into the light control system or existing lighting scenes. Just a few clicks later and your new luminaires can be configured and managed as part of the network. Everything using a single app.

LIGHT GETS SMART.

INTELLIGENT LIGHT MANAGEMENT BY APP. CASAMBI INSIDE BY ROPAG

Rediscover your lighting!

Maximise quality, convenience, and cost efficiency. For general-purpose building lighting ROPAG GmbH offers a new wireless solution: LED luminaires combined with CASAMBI intelligent lighting control as a package solution: CASAMBI *INSIDE*. The innovative luminaire range with integral Bluetooth technology is easy to set up and control using the user-friendly CASAMBI app.

CASAMBI is an intelligent lighting control system that connects and controls wirelessly. The app connects the luminaires through its Bluetooth interface to your tablet or smartphone. This enables you to control up to 127 luminaires via mobile devices or even conventional light switches, simply and in a user-friendly way.

Every CASAMBI module that is integrated in the luminaire is both transmitter and receiver with a range of up to 50 metres (ASH and PWMA4 module), forming its own so-called mesh network. This increases the range of the Bluetooth signal.

It defines parameters such as brightness and colour per

luminaire or luminaire group. The timer enables you to automate entire lighting scenes. CASAMBI can also take sunrise or sunset times into account based on the location and adjust the timer accordingly.

It doesn't matter if you have fluorescent lamps, high voltage halogen lights (230 V) or the most diverse LED lighting solutions. Whether used in an office building, warehouse, hotel lobby, event location, trade show or catering facility. The use of the smart light control system is the perfect solution to create different moods using light, to dim lights, and also to reduce your energy consumption.

In office buildings, Casambi is ideal for meeting workplace requirements according to DIN standards. It is easy to adjust lighting to the necessary light intensity. And at the same time you can also conveniently switch off unnecessary luminaires, for example over lunchtime, conserving your budget.

CASAMBI makes this possible without major renovation work or the need to install complicated electronics.



In industry too, CASAMBI offers a range of possible applications. An additional presence or motion detector can activate the lighting in warehouses when it registers movement or depending on daylight and return it to dimmed mode according to a preset timer. The timer can also be used to automatically switch off any manufacturing lines that are not operating in shift operation. Automatic energy and money savings.

Thanks to the intelligent CASAMBI control system, our luminaires substantially reduce your operating costs. In practice, it is possible to make savings of up to 90 per cent compared with conventional lighting concepts.

And with our new CASAMBI Inside programme benefit from our experience acquired over more than 35 years – get smart!

CASAMBI INSIDE versions are identified as such on the respective product with this logo.

CASAMBI
INSIDE



CASAMBI

FUNCTIONS OF THE APP



The intuitive CASAMBI app instantly finds all the connected modules nearby. To control them, they first need to be assigned to a CASAMBI network. You can set up as many networks in the app as you like.

The maximum network volume is 127 modules. If you find all the required modules in a network, we recommend naming the luminaires and saving a photo of the luminaire for clarity.

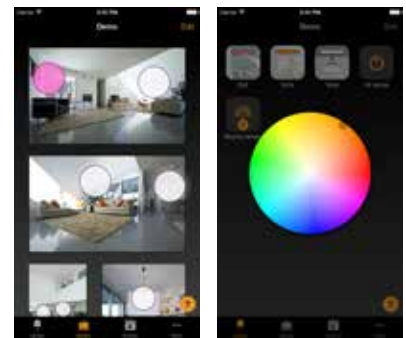

Gallery

Colour temperature



Gallery

Control your luminaires from a photo. Take a photo of the room you want to set up and link the relevant luminaires by selecting them in the image. Then, you can also control your luminaires directly with a click on the image.



Switching luminaires on and off

Using Bluetooth you can conveniently switch the luminaires in a network on and off.



Dimming luminaires

Suitable luminaires can be dimmed. The setting can be saved and reactivated at any time with a click.



Changing the colour temperature

If the connected luminaires have the option of changing the colour temperature, this can be regulated and saved by swiping vertically.



Changing colour

When RGB illuminants are connected, you can adjust the colour simply by using a colour selection wheel. The selected colour can, of course, also be saved.

GESTURES



On/off
Tap once



Colour temperature
Swipe vertically over the luminaire symbol



Dim
Swipe horizontally across the luminaire symbol



Colour
Hold down the luminaire symbol, select colour

iBEACON TECHNOLOGY

iBeacon is based on a transmitter-receiver principle and works with Bluetooth Low Energy technology. iBeacon technology is installed in all CASAMBI modules, which means there is no additional investment for iBeacon transmissions.

iBeacons can be used in museums, for example. Instead of an audio guide, museum visitors can download a museum app, which can receive iBeacon information from CASAMBI devices.

A luminaire that illuminates a piece of art in the museum, and is equipped with a CASAMBI module, displays information on the artwork in the app when the museum visitor is nearby.

CASAMBI FOR HUE

The CASAMBI app is the simplest and most natural way of controlling your luminaires. Besides the luminaires fitted with CASAMBI modules, the app also offers the possibility of controlling Philips Hue illuminants and luminaires.

Setting up the app was designed to be as easy and intuitive as possible. The CASAMBI app is an official Philips Hue partner app.

SECURITY

In the network settings you can manage the access rights of other users to your CASAMBI network. Four different security levels are available. You can decide whether your network is open to any guest or whether you need

to enter a password. If the network is shared with several users and devices, all network changes are automatically synchronised for all devices via the cloud service.



Do not share

The network is only stored on this device.



Only administrator

The network can only be seen and accessed with the administrator's email and password.



Password protected

The network is protected by a guest password. Changes require the administrator password.



Open

The network is freely accessible. Changes require the administrator password.





CASAMBI: SMALL MODULE, GREAT VARIETY

SWITCHING PRINCIPLE

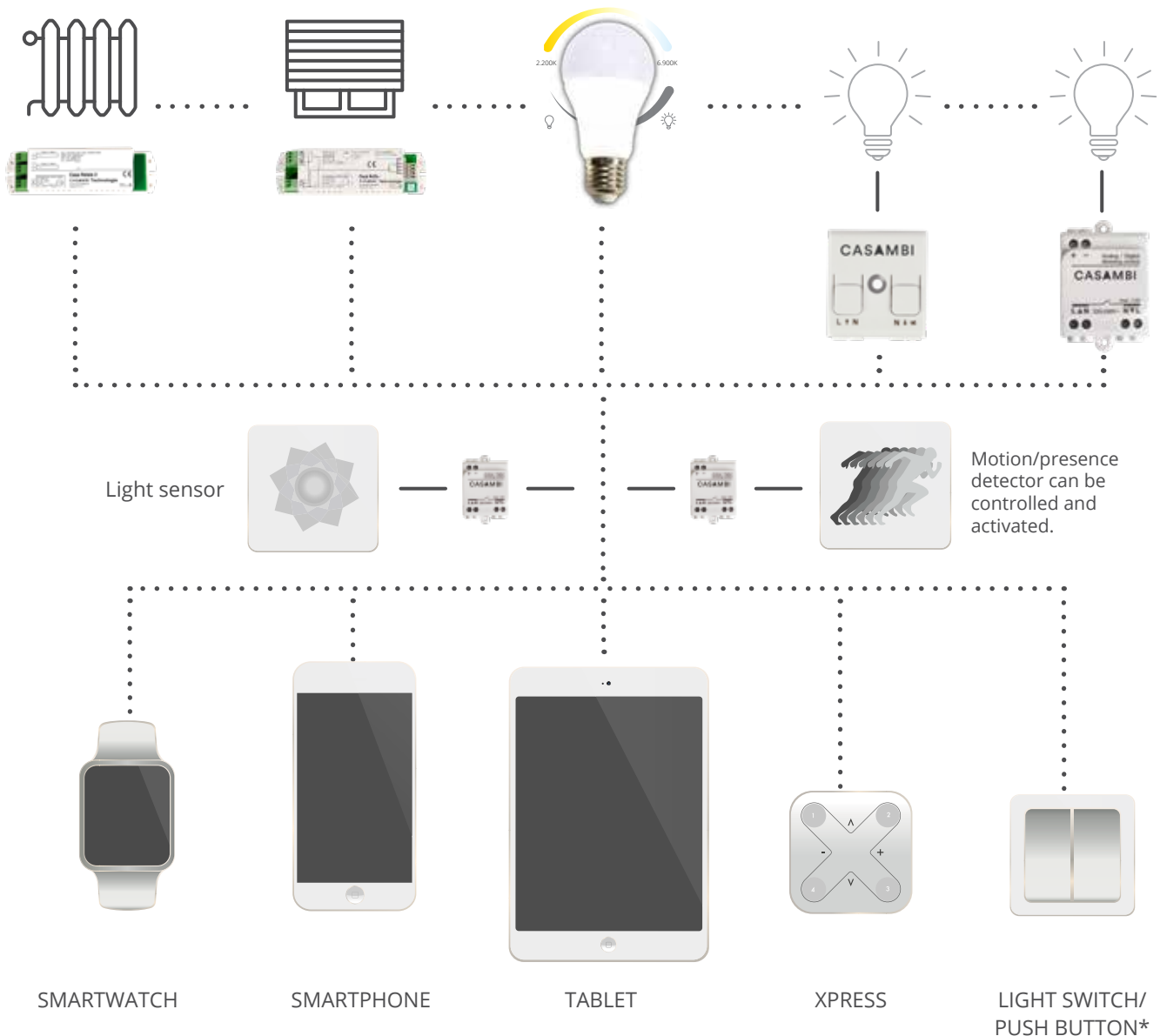

Your existing, conventional light switches can do more! Using CASAMBI not only enables you to use your light switches to turn luminaires on and off, you can also activate preset dimming levels or entire lighting scenes.

Press the switch multiple times. Multiple impulses can trigger different actions in the CASAMBI module.

HOW THE CASAMBI NETWORK WORKS

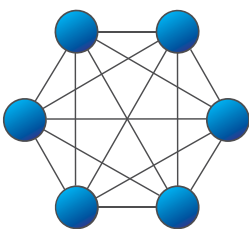

MESH NETWORK
LOW ENERGY

Every CASAMBI module is both a transmitter and receiver, creating an individual Bluetooth network (mesh network). The modules communicate with each other and therefore do not need a central unit. A CASAMBI module automatically contacts all other accessible modules, guaranteeing that all the modules are in the same state.

The wireless range outdoors is approximately 20 m and extends from luminaire to luminaire. At present there are two modules available with different features. Both modules can be easily combined in one network.

* Push button can be programmed by connecting another CASAMBI ASD module.

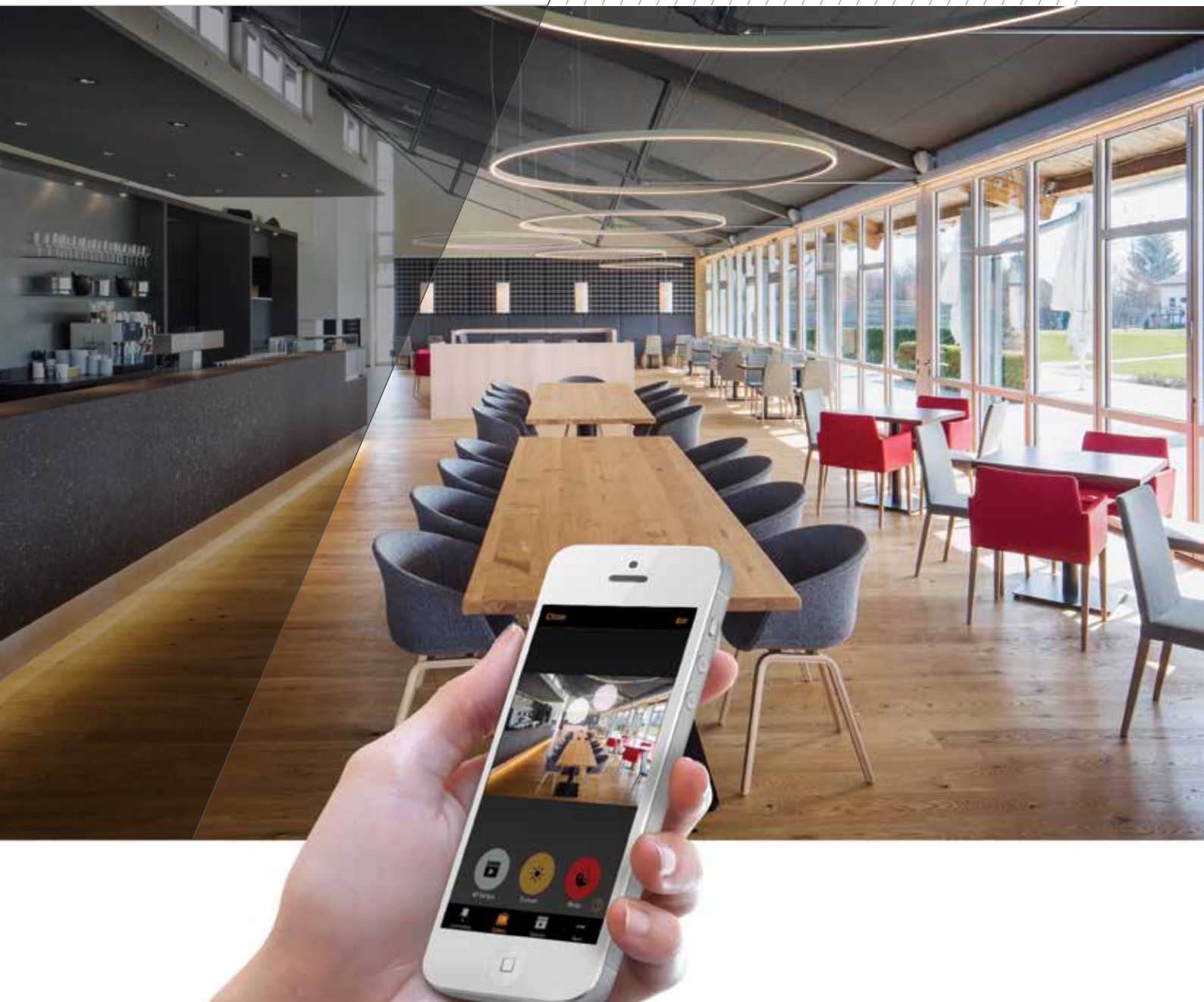

CBU-ASD MODULE

The CBU-ASD unit is a module that can be directly integrated into a luminaire in order to control this wirelessly. It is designed for halogen drivers of 0–10 V, 1–10 V and LED or even DALI dimmer interfaces. It is possible to configure the control output as a digital DALI dimmer interface on site or as an analogue interface.

The modules are controlled wirelessly using the CASAMBI app for smartphone and tablet (via Bluetooth 4.0), though it is also possible to control them using light switches.

CASAMBI CBU-ASD modules also give you the option of controlling a large number of luminaires from anywhere. This is made possible by a secure and wireless mesh network that automatically sets up the units. Set up requires neither repeaters or routers, nor wires or external gateways.



CASAMBI

Bluetooth 4.2 meshed technology App for iOS and Android (from version 4.4 "KitKat")
Configurable analogue/digital output

Luminaires that can be integrated per network:	up to 127
Permitted ambient temperature:	-20 °C to +70°C
Terminals	0.75–1.5 mm ²
Analogue output	0–10 V
Digital output	Standalone DALI 1–4 channels*
Dimensions and weight	57 x 36 x 23 mm, 48 g
Casambi ASD	Item no. CO-CBUASD-01 (0–10 V) Item no. CO-CBUASD-DA (DALI)
Load relay	Item no. PF435899
Max. output capacity	LED: 50 W / Halogen: 150 W

CONNECTION

Connection for push button (displayed in the app as a switch and not as a new luminaire):

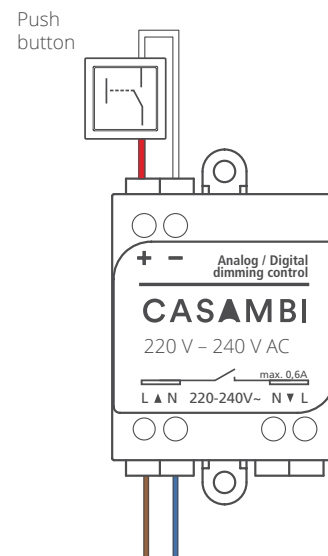
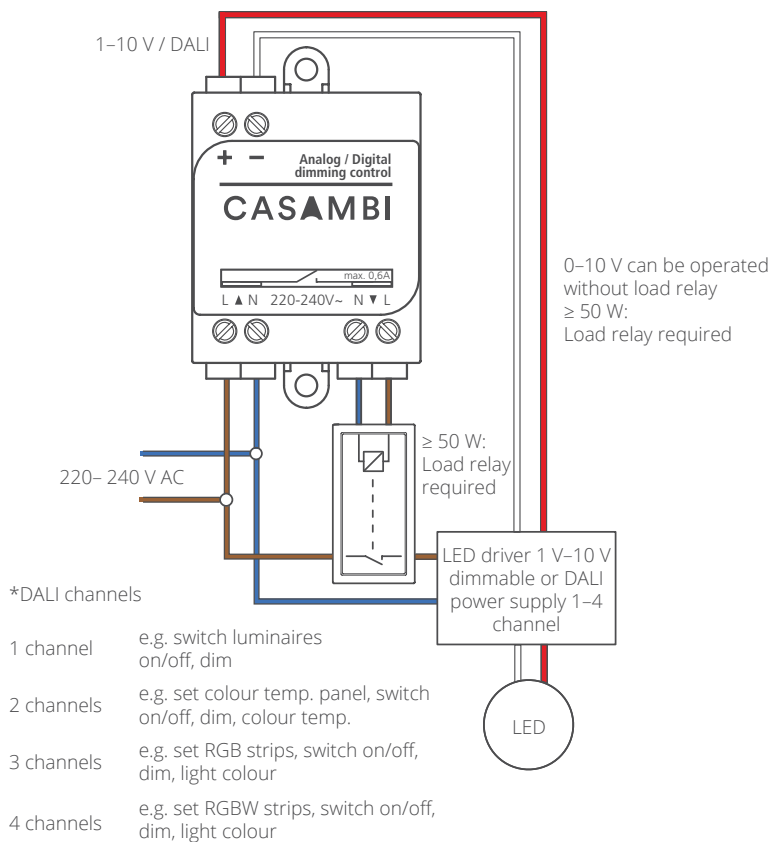

ASD unit configured as a push button
This can be programmed to control the required Casambi luminaires, groups, scenes or animations.

CBU-DCS DALI CONTROLLER



The CBU-DCS is a Bluetooth-controlled CASAMBI DALI module. This module does not require its own mains connection, but instead operates directly via the DALI bus.

The module can be operated with a DALI motion detector or daylight sensor, as well as for controlling a DALI driver, which has its own integrated DALI bus voltage.

Bluetooth 4.2 meshed technology
App for iOS and Android (from version 4.4 "KitKat")

Luminaires that can be integrated per network	up to 127
Permitted ambient temperature	-20 °C to +55 °C
Terminals	0,5 – 1,5mm ²
Digital Output	Standalone DALI 1-4 Channels*
Dimensions and weight	40,4 x 36,3 x 14 mm, 15 g
Casambi ASD	Item no. CO-CBUDCS-DA (DALI)

CONNECTION

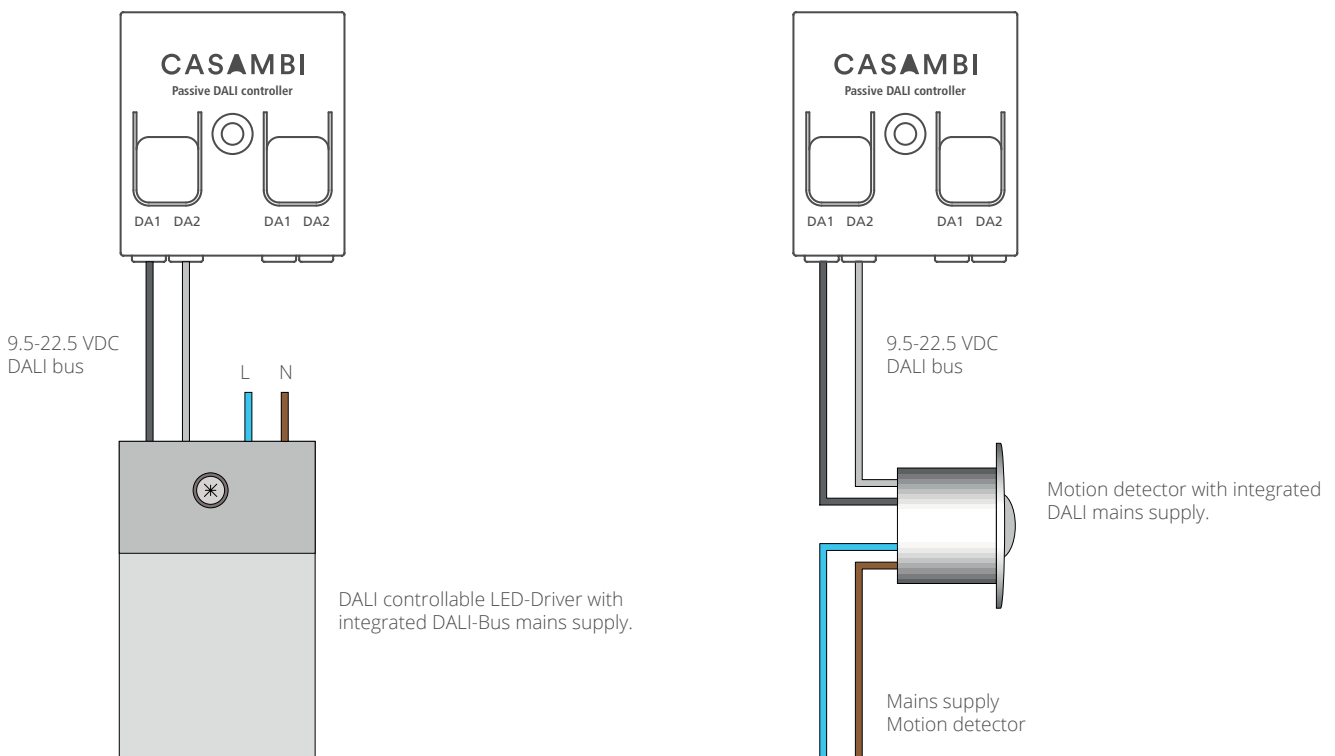

CBU-TED MODULE



The CBU-TED module is a Bluetooth-controlled Casambi trailing-edge dimmer that enables all available illuminants to be continuously dimmed. It can also be used to switch luminaires on and off, and can be installed behind a conventional light switch, in a luminaire or in a terminal box.

CASAMBI

Bluetooth 4.2 meshed technology

App for iOS and Android (from version 4.4 "KitKat")

Luminaires that can be integrated per network

up to 127 (for any number of networks)

Permitted ambient temperature

-20 °C to +45 °C

Terminals

0.5–1.5 mm²

Max. output capacity

150 W

Max. output current

0.65 A

Minimum load

1 W

Dimensions and weight

40.4 x 36.3 x 14.0 mm, 15 g

Casambi TED

Item no. CO-CBUTED-01

CONNECTION

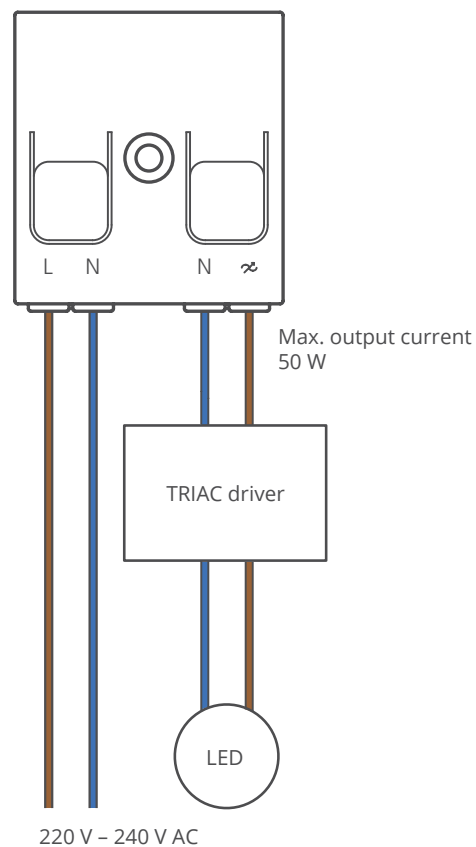



CASAMBI

PWM4 MODULE – modular control, 1-4 channels

This module can be fitted wherever the user needs it and enables direct access to all key functions of the Casambi light control system. For instance the dimming, switching on and off of luminaires, and also setting the RGB and RGBW in the colour selection field. The timer can also be used to preset various scenes.

CONNECTION

**RGBW (1-4 channel) / RGB (1-3 channel)
Adjustable colour temperature (CCT)**

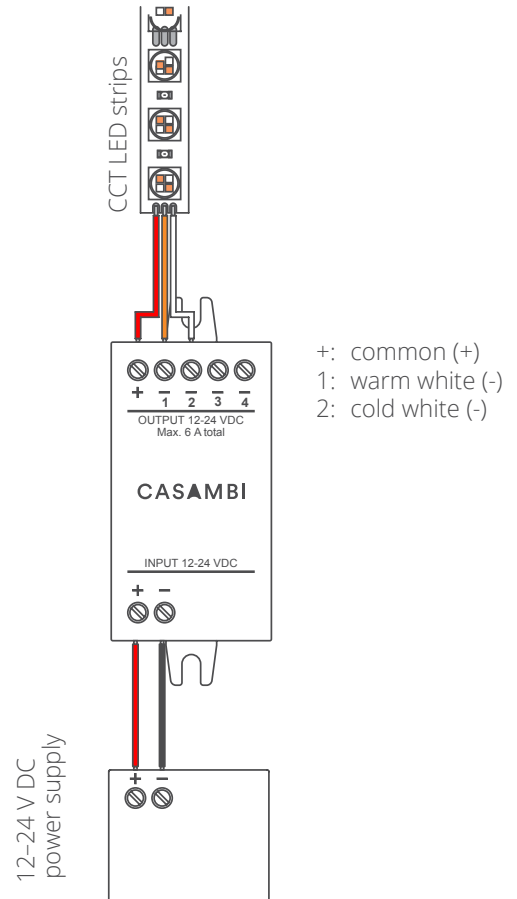
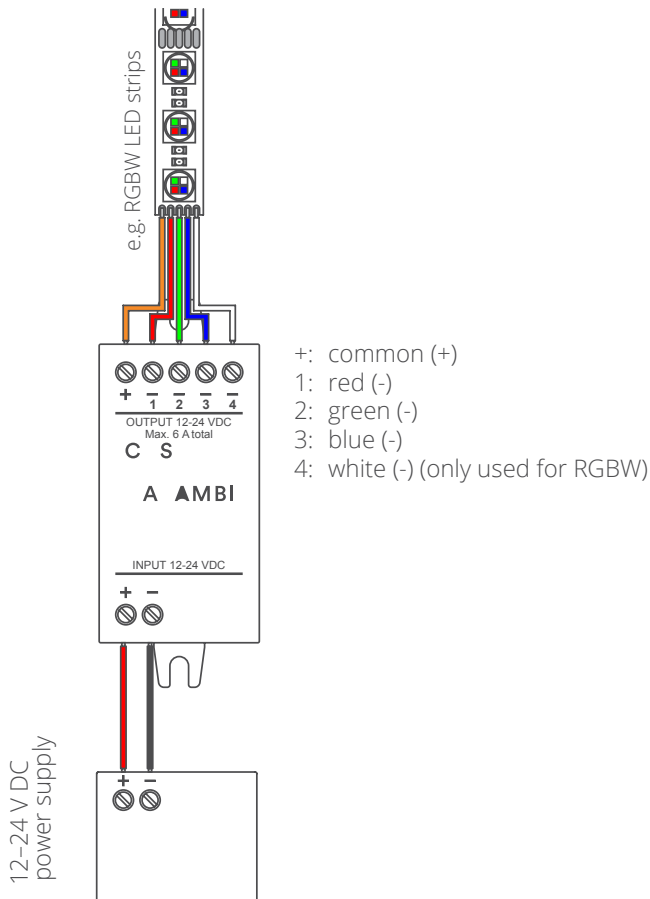

Wireless control of LED luminaires or illuminants app for iOS and Android

Luminaires that can be integrated per network	up to 127 (for any number of networks)
Permitted ambient temperature	-20 °C to +45 °C
Terminals	0.75–1.5 mm ²
Power supply	12 or 24 V
Max. output current	6 A (total current of all 4 channels)
Dimming method	PWM (pulse width modulation)
DC voltage range	12/24 V
Dimensions	72.6 x 30.0 x 18.0 mm
PWM4	Item no. CO-CBUPWM-04

CASAMBI ACCESSORIES

LED-AMPLIFIER

Item no.: CO-1224AM-RG
 Item no.: CO-1224AM-WR

RGB-Amplifier (3 channels)
 RGB+W-Amplifier (4 channels), max. 6 A per channel | 12 / 24 V

1–4 separate channels single-coloured LED strips

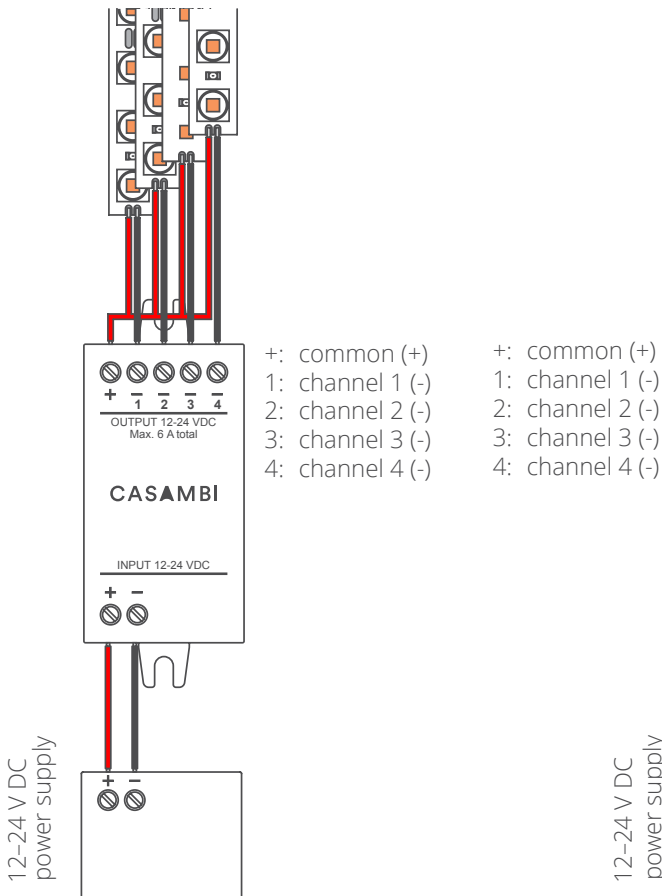

1–4 separate channels single-coloured LED strips incl. booster

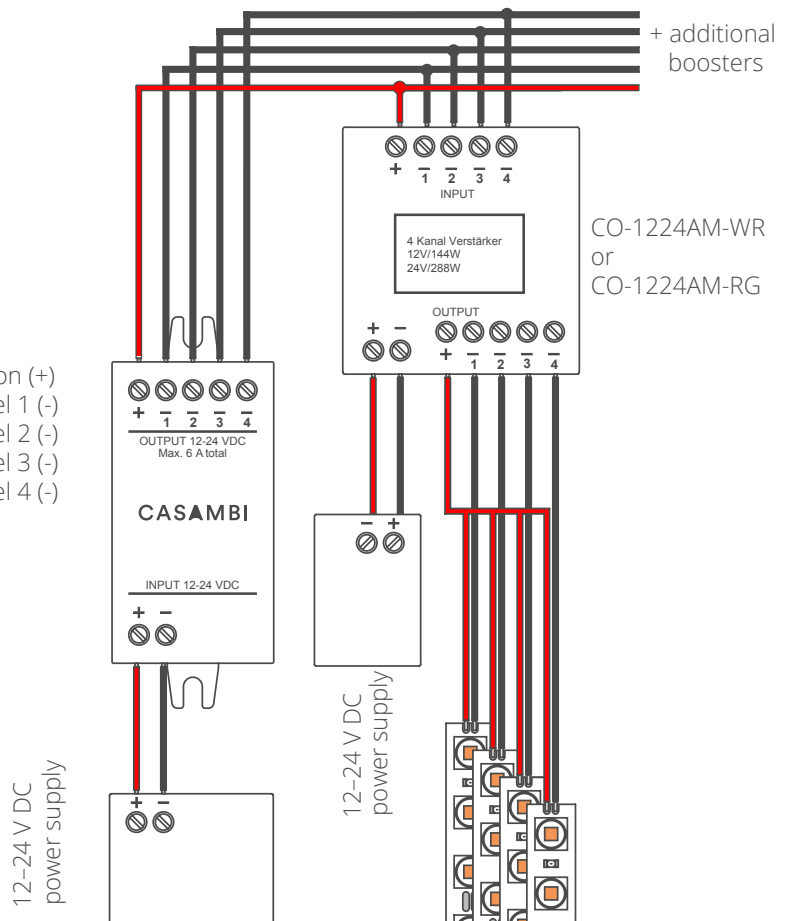

can also be used for RGBW and RGB

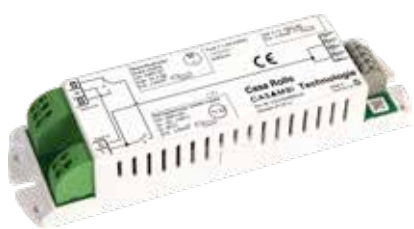

CASAMBI CASA ROLLO

With the roller shutter control, shutters, blinds or awnings can be controlled or operated by push-button or app.

CASAMBI

Maximum motor power	345 VA
Input voltage AC	230 V AC / 50/60 Hz
Current	max. 10 A
Protection class	IP 20
Terminal cross section	max. 1,5mm ²
Dimensions	143 x 38 x 27 mm
Item no.	CO-CASAROLLO



CASAMBI CASA RELAIS

The relay has 2 potential-free contacts. Depending on the contact, the max. Power to be switched. Furthermore, both contacts are independently controllable.



CASAMBI

Maximum switching power	1500 VA (AC) / 165 W (DC)
Input voltage AC	230 V AC / 50/60 Hz
Max. switching Voltage	250 V AC / 28 V DC
Protection class	IP 20
Terminal cross section	max. 1,5mm ²
Consumer	Ohmic consumers
Dimensions	143 x 38 x 27 mm
Item no.	CO-CASARELAIS

LED Power Controller V2 CASAMBI



The CO-TED460W-01 is a CASAMBI trailing-edge controller. This allows continuous dimming via the Casambi app. The controller is designed for an input voltage of 120-277 VAC and max. 2A and can power up to 460W.

Output	max. 460 W
Input voltage	120 - 277 V AC
Current	max. 2 A
Insulation class	IP 20
Dimensions	101 x 51 x 24 mm
Item no.	CO-TED460W-01

CONNECTION

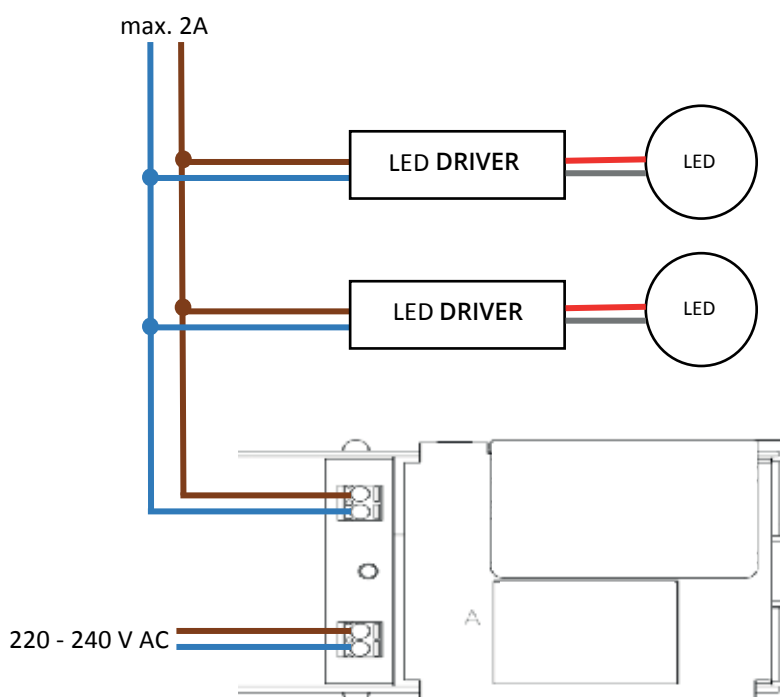

LED Power Controller V2 CASAMBI



This module provides direct access to all important functions of the CASAMBI lighting control and is therefore similar to the PWM4 module. However, the PWM300 can supply consumers with a power consumption of up to 300W.

Output	120 - 300 W
Input voltage	12-30 V AC
Output voltage	12-30 V AC
Current	max. 10 A
Insulation class	IP 20
Terminals	0,25 - 1,5mm ²
Dimensions	99 x 29 x 13 mm
Item no.	CO-PWM300-01

CONNECTION

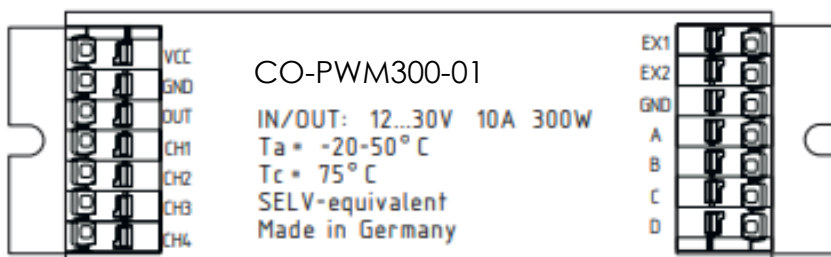

LED Konverter with CASAMBI Bluetooth controller



The NT-TCDC38-01 is a dimmable multi-LED converter for mains powered LEDs. The output current can be adjusted at the coding switch (dip-switch) in steps of 50mA. The converter is easily dimmable through its integrated CASAMBI module via App. It can, however Classically a button for dimming can be connected.

Output	max. 38 W
Input voltage	220 - 240 V AC
Output voltage	10 - 54 V
Current	350 - 1050 mA
Insulation class	IP 20
Terminals	0,5 - 1,5mm ²
Dimensions	146 x 44 x 30 mm
Item no.	NT-TCDC38-01

CONNECTION

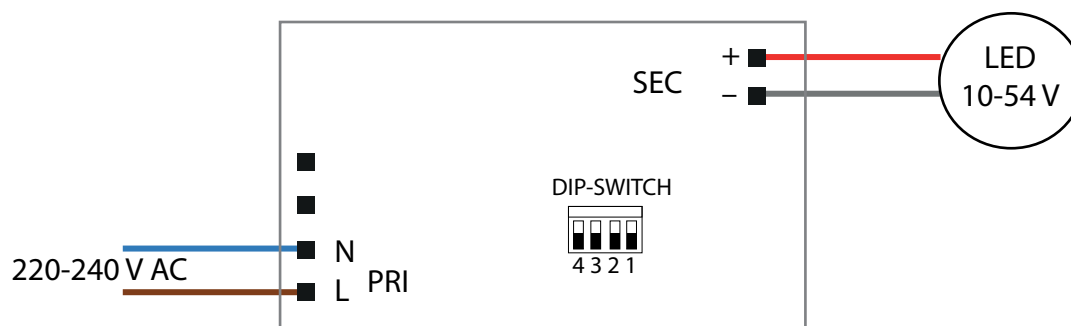

CBU BOX



Use the CO-CBUBOX as the main switch for all modules and luminaires and at the same time the positive side effect of saving energy. With the help of the CBU BOX, all modules can be switched completely de-energized in order not to consume a standby current when switched off. In warehouses or production areas with many spotlights and modules, you can thus achieve a large energy savings.

Item no.: **CO-CBUBOX**

CONNECTION

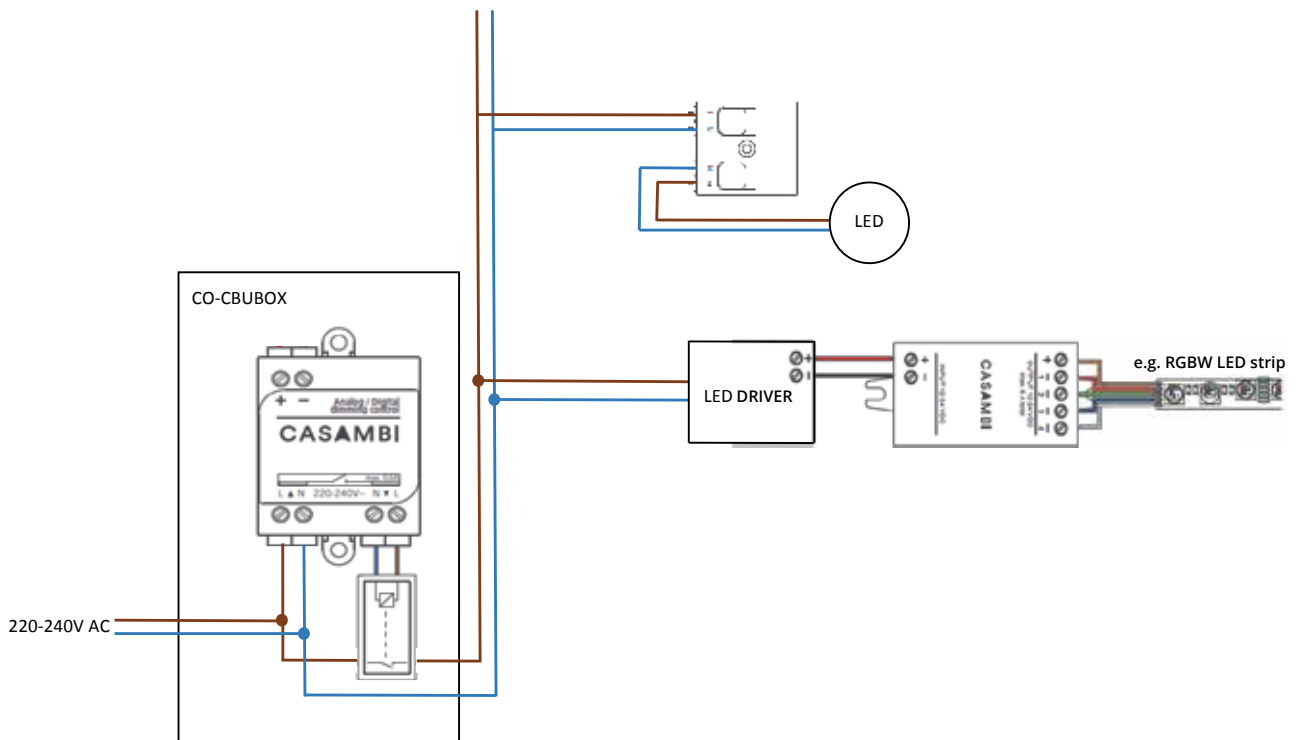



CASAMBI
INSIDE

Available as wireless light switch and also CASAMBI *INSIDE* version.

XPRESS – wireless light switch

Casambi XPRESS is a wireless light switch and remote control at the same time. The XPRESS brings considerable flexibility to interior design as furniture can be moved freely or walls rebuilt without having to consider the wiring for light switches or their placement.

The switch can be fitted wherever the user needs it and enables direct access to all key functions of the Casambi light control system.

Bluetooth 4.2 meshed technology

App for iOS and Android (from version 4.4 "KitKat")

Luminaires that can be integrated per network

up to 127 (for any number of networks)

Colour options

black or white

Range

up to 60 m outdoors

Battery (included)

CR2430 Lithium button cell

Dimensions

90 x 90 x 20 mm

Casambi XPRESS:

Item no. CO-WWSB (black)

Item no. CO-WWSW (white)

Casambi Inside:

Item no. **COCO-WWSW**

Includes:

wall switch and battery CO-WWSW, white, 3 x module CO-CBUTED-01

PUSH BUTTON INTERFACE



This push button has four potential-free push buttons and is managed using the Casambi app. It can be controlled with a conventional light switch and is easy to install in the network with just one click.

Each push button can be configured individually using the app to dim, create a scene or to switch certain luminaires or groups on or off.

CASAMBI

Power supply:	230 V AC, 50 Hz
Power consumption:	max. 10 mA
Cable length to button connections:	max. 300 mm
Stripping length:	8 mm
Dimensions:	ø 53 x 21 mm
Push button interface:	Item no. CO-WWUPTA

CONNECTION

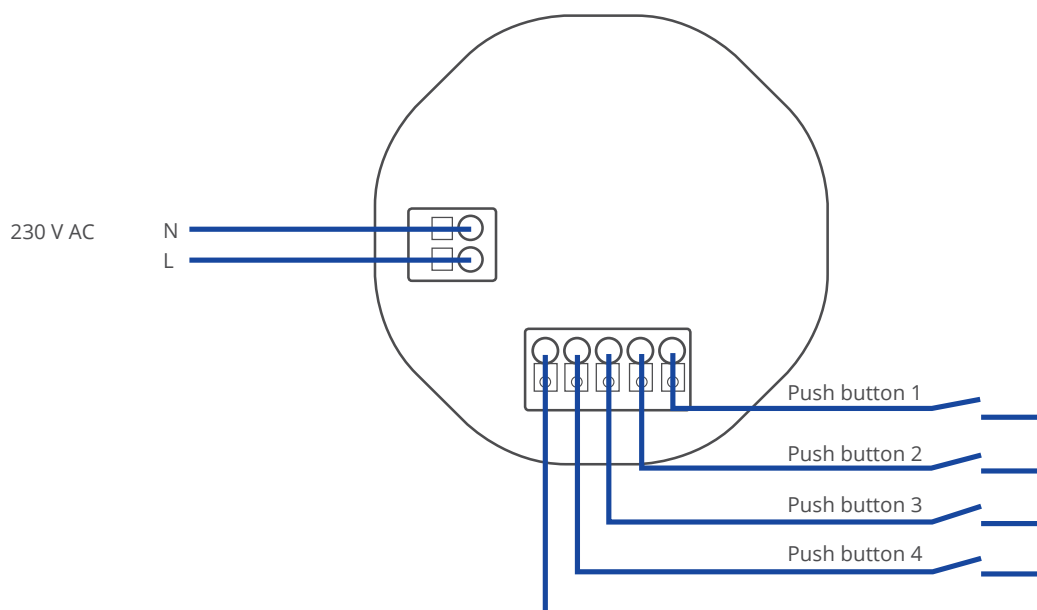



CASA BULB - THE SMART ILLUMINANT

CASAMBI
INSIDE



The CASA BULB CCT illuminant has an integrated CASAMBI controller and can be conveniently controlled via the app from a smartphone or tablet. The light color can be infinitely varied from warm white to cold white.



Casambi Inside:

Item no.: CO-CASABULB-CCTE27 CCT

2.200 - 6.900 K

600-740 lm



IP 20

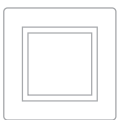

230 V



> 150°



25.000 h



0 sec.



115 x
60mm



CRI
>90

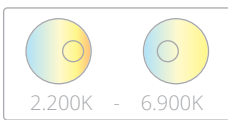

2.200K - 6.900K



dimmable

A+

UGR < 19 (unified glare rating) suitable for use near computer workstations

HIGH POWER – LED panel

Included in our range is the high-performance High Power LED panel at approx. 130 lm/W. Microprisms on the surface ensure even light distribution.

Dimmable TRIAC drivers are also available for this panel so it can be adjusted to your requirements.



HIGH POWER 620–33 W 620 x 620 mm

Casambi Inside:

Item no.: **COPA-626210-NW** neutral white ~4,000 K 4,500 lm



IP 20		230 V	3.34 kg	120°	30,000 h	0 sec.	622 x 622 x 10 mm
625 x 625 mm	CRI > 80	PF 0.9	dimmable	A+			



Surface mounted housing

Item no.: **PA-AUF620-W** Surface mounted housing white for LED-Panel 620 x 620 mm



RGBW – LED Panel

This new grid insert panel is distinguished by its variable LED colour design. These panels can be used for general-purpose lighting (colour temperature change) or for accent lighting (RGB) for special occasions.



CASAMBI
INSIDE

RGBW – 8 W

Casambi Inside:

Item no.: **COPA-181801-RGBW** RGB + neutral white

IP 40		230 V	0,55 kg	120°	50.000 h	0 sec.	180 x 180 x 10mm
180 x 180 mm	CRI >80	PF >0,9	dimmable	RGBW	A+		



CASAMBI
INSIDE

RGBW – 16 W

Casambi Inside:

Item no.: **COPA-303001-RGBW** RGB + neutral white

IP 40		230 V	0,8 kg	120°	50.000 h	0 sec.	295 x 295 x 10mm
295 x 295 mm	CRI >80	PF >0,9	dimmable	RGBW	A+		



CASAMBI
INSIDE

RGBW – 55 W

Casambi Inside:

Item no.: **COPA-626212-RGBW** neutral white ~4.000 K 3.330 lm (for NW)

IP 20		230 V	3,8 kg	120°	30.000 h	0 sec.	620 x 620 x 10mm
625 x 625mm	CRI >80	PF >0,9	dimmable	RGBW	A		

CCT - LED Panel

Light does not only serve visual needs, but it can also increase motivation, well-being and productivity in the workplace with the help of color temperature changing panels and Human Centric Lighting (HCL).

This use of light is made possible by new insights into the effects of light on humans and the latest innovations in lighting technology.

With our CCT panels and our CASAMBI motion detectors / daylight sensors, you can easily adjust the lighting in your office to the daily rhythm, increasing your productivity and well-being in the workplace.



CASAMBI
INSIDE

VARIO CCT - 8 W

Tunable white

Casambi Inside:

Item no.: **COPA-181801-CCT** tunable white

2.700 - 6.000 K 680 lm

 IP 40		 230 V	 0,55 kg	 120°	 50.000 h	 <0,2 sec.	 180 180 x 10mm
 180 x 180 mm	 CRI >80	 PF >0,9	 2.700K - 6.000K	 dimmable	 A+		



CASAMBI
INSIDE

VARIO CCT - 24 W

Tunable white

Casambi Inside:

Item no.: **COPA-303001-CCT** tunable white

2.700 - 6.000 K 2.040 lm

IP 40		230 V	0,8 kg	120°	50.000 h	<0,2 sec.	295 295 x 10mm
295 x 295 mm	CRI >80	PF >0,9	2.700K - 6.000K	dimmable	A ⁺		



CASAMBI
INSIDE

VARIO CCT - 48 W

Tunable white

Casambi Inside:

Item no.: **COPA-626212-CCT** tunable white

2.700 - 6.000 K 3.900 lm

IP 40		230 V	3,45 kg	120°	20.000 h	<0,2 sec.	620mm 620 x 10mm
620 x 620 mm	CRI >80	PF >0,9	2.700K - 6.000K	dimmable	A		



EDGE - LED frame panel

Our EDGE is a new type of panel which is ideal for grid ceiling. Be bold with a novel design and set yourself apart from the mainstream. These frame panels are the trailblazers of

a new generation of panels with high luminosity and useful life, along with up to 90 % energy savings.

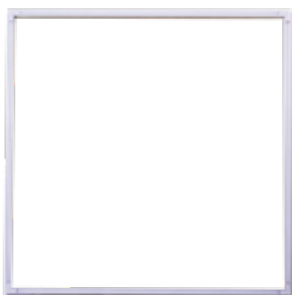



CASAMBI
INSIDE

EDGE 620 - 40 W

Casambi Inside:

Item no.: **COPA-006262-NWT** neutral white

~4.000 K 4.000 lm

 IP 20		 230 V	 0,43 kg	 120°	 40.000 h	 0 sec.	 610 610 x 13mm
 625 x 625mm	 CRI >80	 PF 0,9	 dimmable	 A			

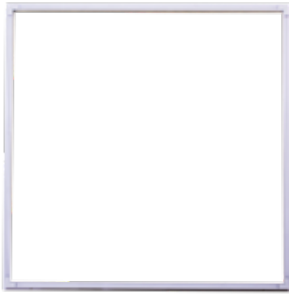

CASAMBI
INSIDE

EDGE 620 CCT - 40 W

Casambi Inside:

Item no.: **COPA-006262-CCT** tunable white

2.700 - 6000 K

4.000 lm

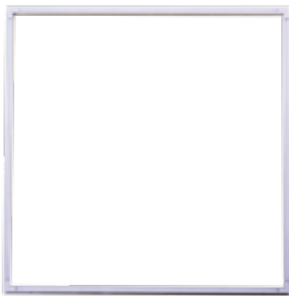
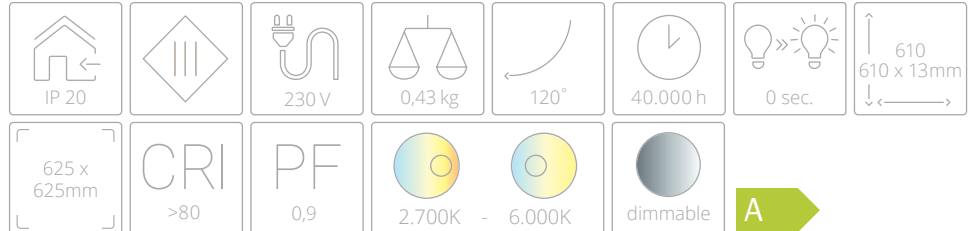

CASAMBI
INSIDE

EDGE 620 RGBW - 40 W

Casambi Inside:

Item no.: **COPA-006262-RGBW** RGBW + neutral white

~4.000 K

4.000 lm



PLANO – LED panel with ultra-flat design

Our PLANO is a unique LED panel with ultra-flat design and brand new technology. The PLANO LED panel is available in two sizes. Only a 68 mm wall or ceiling section needs to be cut out for its installation. The mount is simply installed in a conventional socket cavity (not supplied).

The panel is then held in place by two strong magnets, which are housed in the mount and in the panel. It can be removed at any time, simply and conveniently without using tools, which is a considerable advantage when cleaning or during renovation work.

PLANO 10 – 10 W



CASAMBI
INSIDE











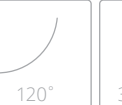

Casambi Inside:

Item no.: COPA-013610-NW

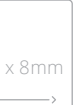
neutral white

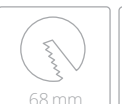
~4,000 K

800 lm

 IP 20		 230 V	 0,08 kg	 120°	 30.000 h	 0 sec.	 136 x 8mm
 CRI 80	 68 mm		 dimmable	 A			

PLANO 20 – 20 W



CASAMBI
INSIDE











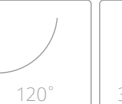

Casambi Inside:

Item no.: COPA-019620-NW

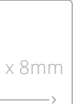
neutral white

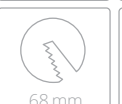
~4,000 K

1,700 lm

 IP 20		 230 V	 0,19 kg	 120°	 30.000 h	 0 sec.	 195 x 8mm
 CRI 80	 68 mm		 dimmable	 A			

AVE – round recessed panel

Create spectacular light accents using our AVE recessed panel with a particularly discreet aluminium frame. This is available in 4 different sizes (115–300 mm) and brightnesses (360–1600 lm).

Depending on its size, this panel needs just 6 to a maximum of 20 watt as a result of the LED technology used. The dimming capacity of the luminaires ensures flexible adaptation to your requirements.

AVE 20 – 20 W

Casambi Inside:

Item no.: COPA-030001-NW

neutral white

~4,000 K

1,600 lm



CASAMBI
INSIDE

UGR < 19 (unified glare rating) suitable for use near computer workstations

LAVA – LED free-standing luminaire

This free-standing office luminaire with timeless design in silver also includes an integrated presence detector and day-light sensor. It consists of three parts: Top, pole, and foot section. It is a practical addition to your work as at 40 watt it shines both upwards and downwards, making it especially easy on the eyes. As required, you can adjust the brightness or turn it off simply and conveniently on the touch area.



LAVA – 2 x 40 W UP & DOWN

Casambi Inside:

Item no.: COHO-195460-NW

neutral white

~4,000 K

7,100 lm



CASAMBI
INSIDE



TONDO – exterior façade luminaire

These traditional, timeless luminaires can be installed both on ceilings and exterior walls. They are fitted with the latest LED technology. The frame is available in dark grey or white and so can be integrated in any façade design. An output of 13 watt makes Tondo the ideal replacement for halogen luminaires.

TONDO – 13 W

Casambi Inside:

Item no.: COHO-2708DG-WW warm white

~3,000 K

900 lm



CASAMBI
INSIDE

RONDA – ceiling luminaires

Thanks to the discreet circular shape the RONDA ceiling luminaire blends perfectly into every room. Its welcoming light is equally at home in the office or in living areas. The LED illuminant, which has a useful life of approx. 40,000 hours, and the luminaire's capacity of just 26 watt makes it energy efficient.

RONDA – 26 W

Casambi Inside:

Item no.: COLW-395S26-NW neutral white

~4,000 K

1,600 lm

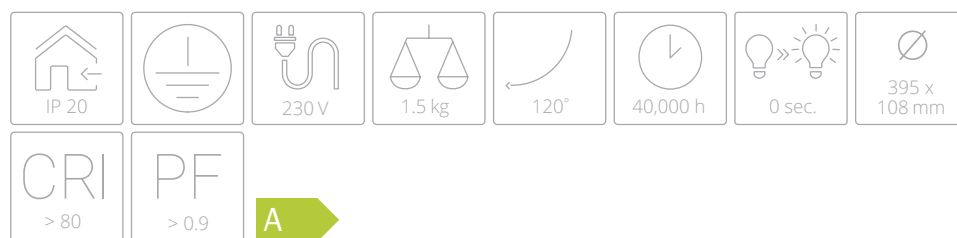

CASAMBI
INSIDE

CANTONE – LED downlight

Our CANTONE LED downlight is a recessed spotlight. For the perfect lighting effect, choose between four different covers in white, chrome, matt chrome, and brushed metal. The covers are available in round or square designs.

CANTONE only needs a 68 mm section to be cut from the ceiling and has a recess depth of just 35 mm for 5 W. You can even make this spotlight dimmable by using TRIAC or DALI drivers.



The covers come in a round or square design in four surface variations.



CASAMBI
INSIDE

CANTONE 5 – 5 W













Casambi Inside:

Single set:

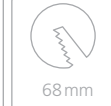
Item no.: COED-053602-NW1 neutral white ~4,000 K 400 lm

Triple set:

Item no.: COED-053602-NW3 neutral white ~4,000 K 400 lm

 IP 20		 230 V	 0.14 kg	 38°	 40,000 h	 0 sec.	 68 mm
 CRI > 80	 PF 0.85		 dimmable	 A			

ACCESSORIES FOR CANTONE

The Cantone LED downlight is a recessed spotlight. To integrate this recessed luminaire perfectly in your room, you can select the right cover from four different surfaces in a round or square design.

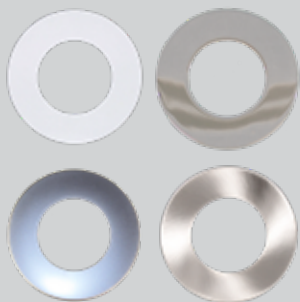

ROUND COVERS $\varnothing 94 \times 4$ mm

Item no.: ED-RB001W-ST	white
Item no.: ED-RB001C-ST	chrome
Item no.: ED-RB001M-ST	chrome matt
Item no.: ED-RB001N-ST	brushed metal



SQUARE COVERS 94 x 94 x 4 mm

Item no.: ED-QB001W-ST	white
Item no.: ED-QB001C-ST	chrome
Item no.: ED-QB001M-ST	chrome matt
Item no.: ED-QB001N-ST	brushed metal



Moisture-proof diffuser luminaire - with integrated LED bar

These diffuser luminaires with integrated LED bar are equipped with CASAMBI *INSIDE* and are perfect for car parks. This control system saves you up to 90 % energy.



CASAMBI
INSIDE

LED DIFFUSER LUMINAIRE – 38 W

Casambi Inside:

Item no.: **COTU-FW1220-NW** neutral white ~4.000 K 4.800 lm

 IP 65		 220-240 V 50-60Hz	 1,8 kg	 IK 08	 120°	 50.000 h	 0 sec.
 1.220 x 97 x 82mm	 CRI >80	 PF 0,9	 DC tauglich	 A+			



CASAMBI
INSIDE

LED DIFFUSER LUMINAIRE – 38 W

Casambi Inside:

Item no.: **COTU-FW1220-NWD** neutral white ~4.000 K 4.800 lm

 IP 65		 220-240 V 50-60Hz	 1,8 kg	 IK 08	 120°	 50.000 h	 0 sec.
 1.220 x 97 x 82mm	 CRI >80	 PF 0,9	 DC tauglich	 dimmable	 A+		



CASAMBI
INSIDE

LED DIFFUSER LUMINAIRE – 56 W

Casambi Inside:

Item no.: **COTU-FW1560-NW** neutral white

~4.000 K 7.500 lm

IP 65		220-240 V 50-60Hz	2,2 kg	IK 08	120°	50.000 h	0 sec.
1.560 x 97 x 82mm	CRI >80	PF 0,9	DC tauglich	A+			



CASAMBI
INSIDE

LED DIFFUSER LUMINAIRE – 56 W

Casambi Inside:

Item no.: **COTU-FW1560-NWD** neutral white

~4.000 K 7.500 lm

IP 65		220-240 V 50-60Hz	2,2 kg	IK 08	120°	50.000 h	0 sec.
1.560 x 97 x 82mm	CRI >80	PF 0,9	DC tauglich	dimmable	A+		

CASAMBI

Motion detector CO-CBU-HBWD66

The LED moisture-proof diffuser luminaires can be combined with the motion detector CO-CBU-HBWD66. This can achieve energy savings of up to 90% (see page 52).



IP66



PREMIUM – LED high-bay luminaire

SAMSUNG LED Casambi dimmable

This high-quality LED high-bay luminaire is perfect for illuminating warehouses, workshops etc. The luminaire comes ready for installation including eyelet and approx. 30 cm cable. Dimming is achieved using the DALI input.

PREMIUM 150 – 150 W

Casambi Inside:

Item no.: COHA-150153-NW

neutral white

~4,200 K 18,000 lm



CASAMBI
INSIDE

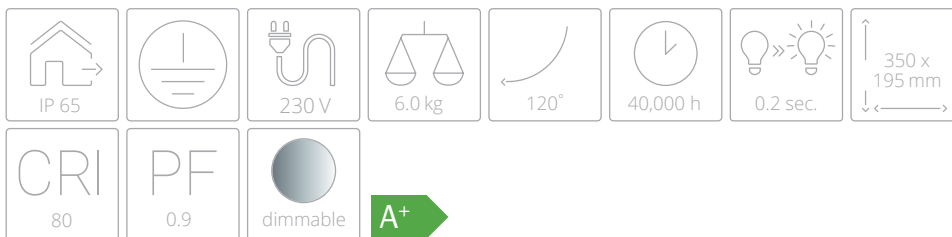



PREMIUM 240 – 240 W

Casambi Inside:

Item no.: COHA-240243-NW

neutral white

~4,000 K

31,200 lm



CASAMBI
INSIDE

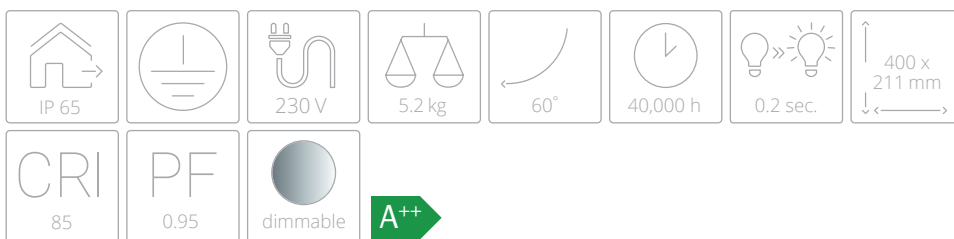

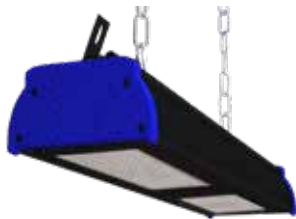

Specialist optics for shelving

CASAMBI
INSIDE

LINEAR HIGHBAY – 100 W

Casambi Inside:

Item no.: COHA-LI100DALI-01 neutral white

~4,000 K

13,000 lm

 IP 66		 230 V	 3.0 kg	 120°	 30,000 h	 0 sec.	 600 x 141 x 134 mm
 CRI 80	 PF 0.9	 dimmable					



CASAMBI
INSIDE

DACH HIGHBAY – 150 W

Casambi Inside:

Item no.: COHA-150150-NW neutral white

~4,000 K

21,000 lm

 IP 66		 230 V	 5.2 kg	 120°	 30,000 h	 0 sec.	 600 x 141 x 134 mm
 CRI 80	 PF 0.9						

ACCESSORIES – LED high-bay luminaire

To change the beam angle of the premium LED high-bay luminaire, you can also use an aluminium reflector. This enables you to focus the light in the perfect position.

SALO 50 – 50 W floodlight

Casambi Inside:

Item no.: COFL-051201-NW

neutral white

~4,200 K

4,200 lm



CASAMBI
INSIDE





FLEXSTRIP – LED indoor strip lighting

High-quality LED strip lighting for indirect illumination to showcase your furniture or immerse your home in a soft glow. The flexstrip LED strip lights are available from 150–3,400 lm in neutral and warm white. The closely positioned LEDs generate a large beam angle and therefore a consistent and extensive illumination.

The LED positioning in this model means that there are no visible light points. On the reverse they are supplied with adhesive tape so that they can be directly fitted without problem. However, we recommend fixing to a metallic surface to ensure adequate cooling.



FLEXSTRIP 5m – 4,8 W / m

Casambi Inside:

Item no.: COFB-048004-WW

warm white

3.000 K

300 lm

CASAMBI
INSIDE

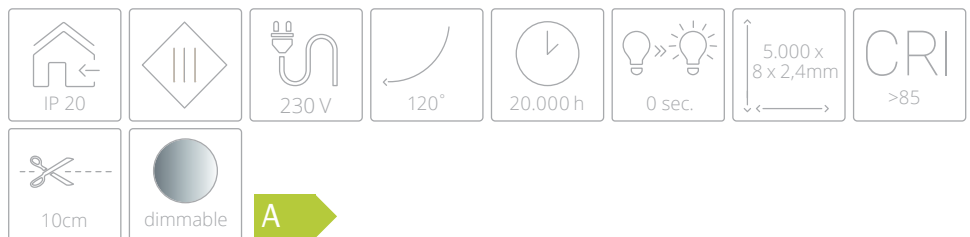

FLEXSTRIP 5m – 9,6 W / m

Casambi Inside:

Item no.: COFB-096004-WW

warm white

3.000 K

600 lm

CASAMBI
INSIDE

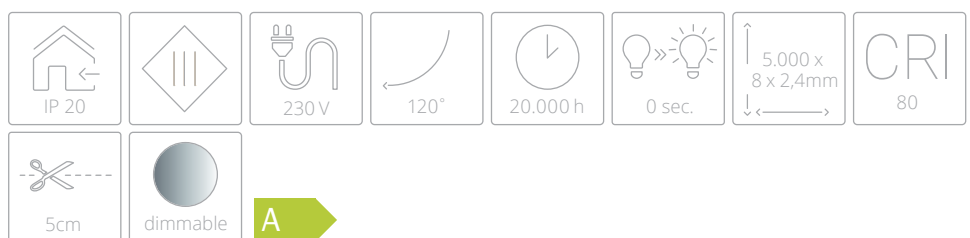

RGB FLEXSTRIP 5m – 14,4 W / m

Casambi Inside:

Item no.: COFB-144004-RG

R: 120 lm | G: 240 lm | B: 150 lm



CASAMBI
INSIDE

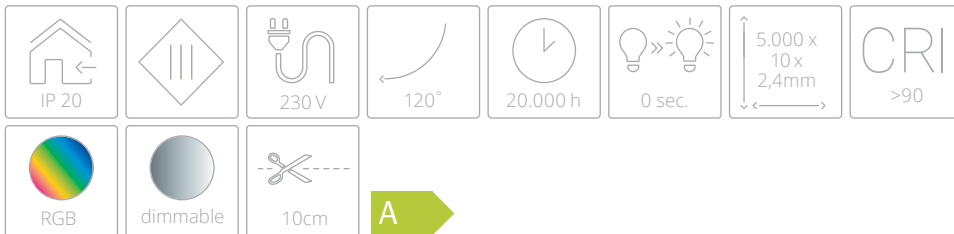

LED FLEXSTRIP 5m roll – 28,8 W / m

Casambi Inside:

Item no.: COFB-288004-NW

neutral white

4.000 K

2.780 lm

COFB-288004-WW

warm white

3.000 K

2.560 lm



CASAMBI
INSIDE



NEW!
Close-fitting LED for
extensive illumination!

RGB LED FLEXSTRIP 5m roll – 28,8 W / m

Casambi Inside:

Item no.: COFB-288004-RG

RGB



CASAMBI
INSIDE



NEW!
Close-fitting LED for
extensive illumination!



Light control system using motion detectors

Casambi motion detectors consist of integrated Casambi technology and make it possible to control luminaires without wiring work. Use the Casambi app to configure parameters such as brightness and automatically switching on and off at dusk or movement. This can result savings of up to 90 per cent.

The sensors are available in various designs for ceiling mounting or recessed installation and various detection zones from 5 to 28 m.

Our SWISSPIR is the smallest in the series and can be discreetly integrated in room designs.

CO-CBU-CESR



CASAMBI

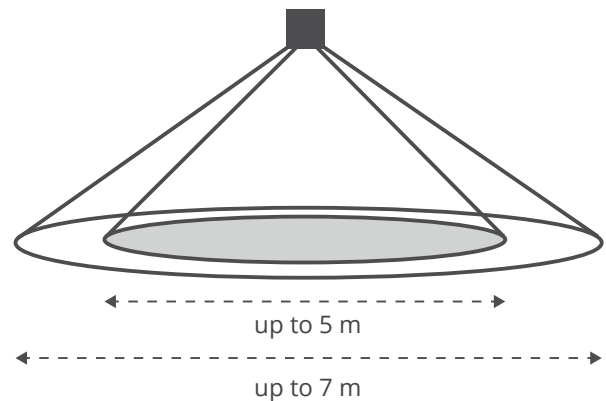

Bluetooth 4.0 meshed technology
App for iOS and Android (from version 4.4 "KitKat")
Luminaires that can be integrated per network

up to 127 (for any number of networks)

Colour options:

white

Detection zone:

up to 5 m for a ceiling height of 2.40 m

Dimensions:

54 x 91 mm

Infrared sensor:

Item no. CO-CBU-CESR

CO-CBU-CEFL



CASAMBI

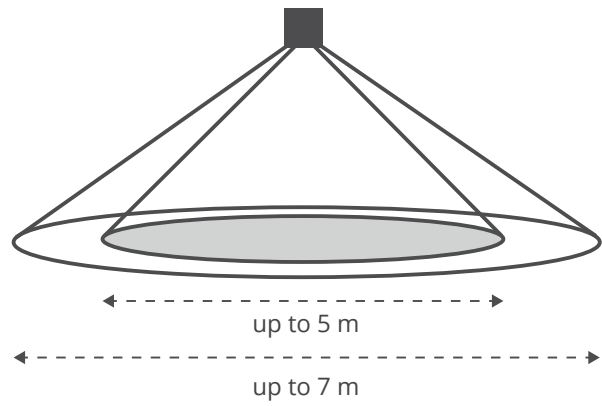

Bluetooth 4.0 meshed technology

App for iOS and Android (from version 4.4 "KitKat")

Luminaires that can be integrated per network

up to 127 (for any number of networks)

Colour options:

white

Detection zone:

up to 5 m for a ceiling height of 2.40 m

Drill hole diameter:

Ø 60 mm

Dimensions:

85 x 88 mm

Infrared sensor:

Item no. CO-CBU-CEFL

CO-SWISSPIR

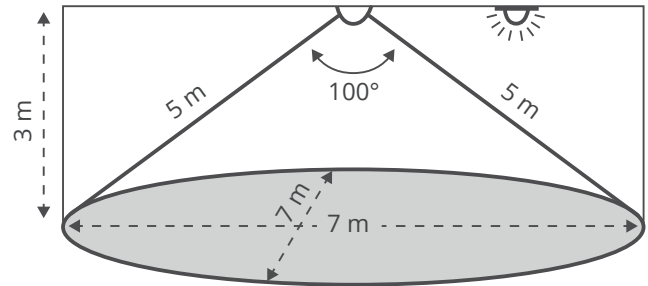

Bluetooth 4.2 meshed technology
 App for iOS and Android (from version 4.4 "KitKat")
 Luminaires that can be integrated per network

up to 127 (for any number of networks)

Colour options:	white
Detection zone:	up to 6 m for a ceiling height of 3 m
Drill hole diameter:	Ø 25 mm
Dimensions:	48 x 38 mm
Infrared sensor:	Item no. CO-SWISSPIR



CO-CBU-HBWD



CASAMBI

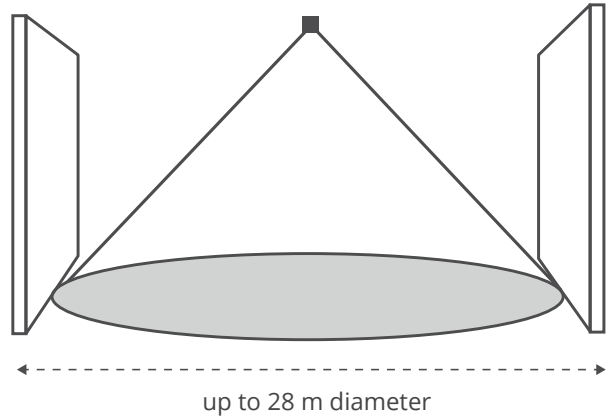

Bluetooth 4.2 meshed technology
App for iOS and Android (from version 4.4 "KitKat")
Luminaires that can be integrated per network

up to 127 (for any number of networks)

Colour options:

white

Detection zone:

up to 27 m for a ceiling height of 14 m

Dimensions:

90 x 63 mm

Infrared sensor:

Item no. CO-CBU-HBWD



CO-CBU-HBWD66



CASAMBI

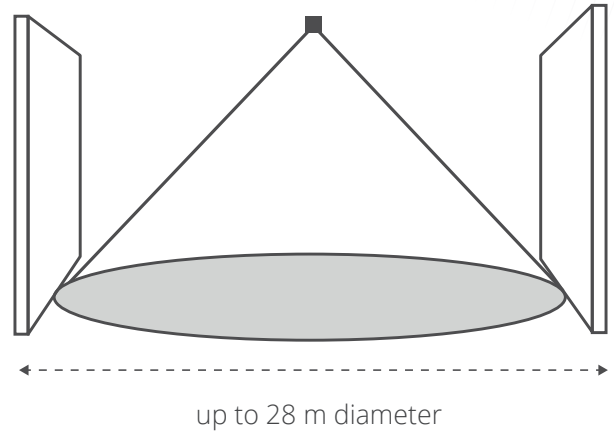

Bluetooth 4.2 meshed technology
 App for iOS and Android (from version 4.4 "KitKat")
 Luminaires that can be integrated per network

up to 127

Colour options:

white

Detection zone:

up to 28 m for ceiling heights of 14 m

Dimensions

110mm x 110mm x 73mm

Infrared sensor

Item no. CO-CBU-HBWD66

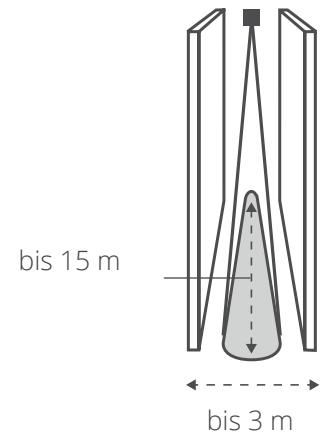

CO-CBU-HBND**IP66****CASAMBI**

Bluetooth 4.2 meshed technology
 App for iOS and Android (from version 4.4 "KitKat")
 Luminaires that can be integrated per network

up to 127

Colour options:

white

Detection zone:

Up to 15 x 3 m floor area at ceiling heights of 12 m

Diameter drillhole:

ø 25 mm

Dimensions

110mm x 110mm x 73mm

Infrared sensor

Item no. **CO-CBU-HBND**

CO-CBU-HBSP

IP66

CASAMBI

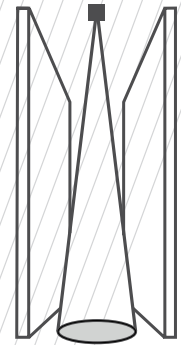

up to 5 m diameter

Bluetooth 4.2 meshed technology
 App for iOS and Android (from version 4.4 "KitKat")
 Luminaires that can be integrated per network

up to 127

Colour options:

white

Detection zone:

up to 5 m for ceiling heights of 20 m

Dimensions:

110mm x 110mm x 73mm

Infrared sensor:

Item no. CO-CBU-HBSP



LEGEND



Protection class

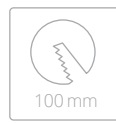

Round cutout



Insulation class I;
PE conductor connection available



Square cutout



Insulation class II;
Protection via reinforced insulation.



Cover



Insulation class III;
Protection via extra-low voltage



Colour rendering index



Power supply



Power factor



Weight



Suitable for DC
operation



Beam angle



Product is
dimmable

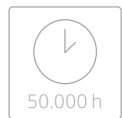

Average service life (L70)

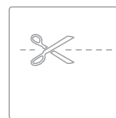

Separation possible



Ignition

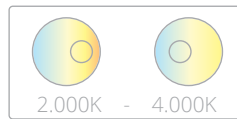

Warm white
neutral white



Dimensions



Available for iOS
and Android



Grid dimensions



Shockproof

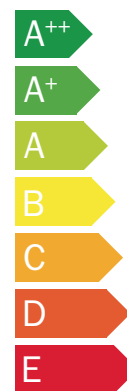

Energy efficiency
category of the
product



ROPAG GmbH

Hermann-Staudinger-Straße 10 - 16
63110 Rodgau

Tel +49 6106 660 28 - 50

Fax +49 6106 660 28 - 70

Mail sales@ropag.de

www.rp-group.com